

POVRATNI VALJAK SA GUMENIM PRSTENOVIMA ZA RAVNU (MONO) TRAKU
 RETURN ROLLER WITH RUBBER DISCS FOR FLAT (MONO) BELT

Tip – VGM – Type

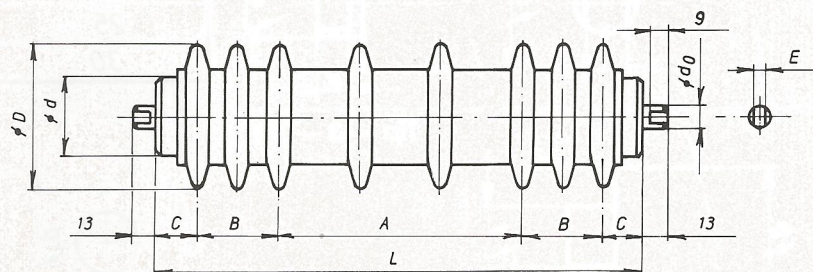

ŠIRINA TRAKE BELT WIDTH	D	d	d ₀	L	A	B	C	E	MASA – kg – Mass
400	133	63,5	20	500	160	3 X 50	30	14	5,8
500				600	2 X 120				6,8
600				700	2 X 180	60	110		7,2
650				750	3 X 130	3 X 50	30		7,7
750				850	4 X 127,5	60	110		8,2
800	159	89	25/30	950	4 X 112,4	4 X 50	30	18 / 22	13,3 / 15,0
900				1000	5 X 132	60	110		14,6 / 16,3
1000				1150	5 X 138	4 X 50	30		17,3 / 18,7
1050				1160	5 X 162	60	115		17,5 / 18,9
1200				1310	6 X 160	60	40/115		20,2 / 22,7
1400				1600	5 X 184	5 X 60	40		25,3 / 27,6
1600				1800	6 X 187,5		37,5		33,3 / 37,1

POVRATNI VALJAK SA GUMENIM PRSTENOVIMA ZA KORITASTU (DUO) TRAKU
 RETURN ROLLER WITH RUBBER DISCS FOR TROUGH - SHAPED (DUO) BELT

Tip – VGD – Type

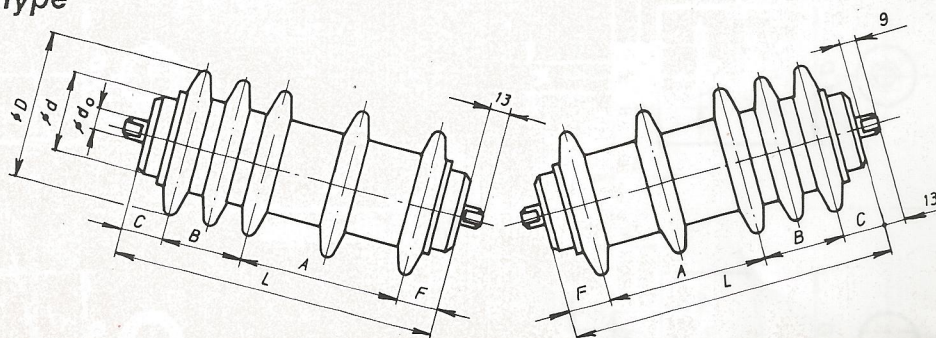

ŠIRINA TRAKE BELT WIDTH	D	d	d ₀	L	A	B	C	F	MASA – kg – Mass	
400	133	63,5	20	250	0	3 X 50	50	50	5,9	
500				315	105			30	6,9	
650				380	140			60	7,8	
800	159	89	25	465	2 X 100	4 X 50	30	35	14,6	
1000				600	2 X 140	5 X 50		40	18,2	
1200				700	3 X 135	4 X 60		25	30	20
1400				800	3 X 140	5 X 60	40	60	40	22
1600				900	4 X 130					24,2
1800				1000	4 X 150					27
2000				1100	5 X 140					30

OBLICI ZAVRŠETAKA OSOVINA – SPINDLE END TYPES

Tip – 1 – Type

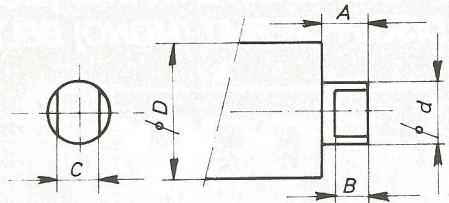

Osovina - d-Axle	A	B	C
20	13	9	14
25			18
30			22

Tip – 2 – Type

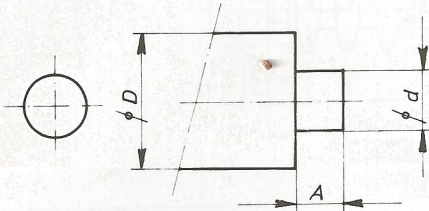

Tip – 3 – Type

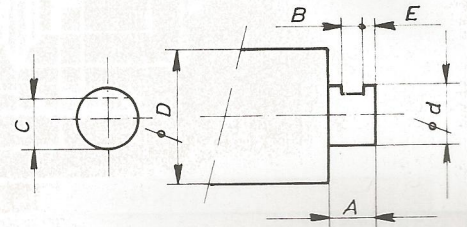

Tip – 4 – Type

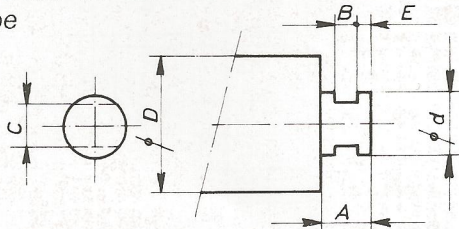

Tip – 5 – Type

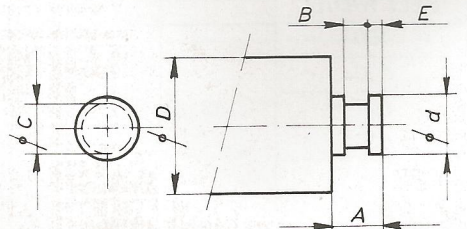

Tip – 6 – Type

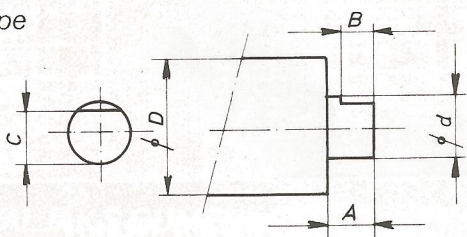

Tip – 7 – Type

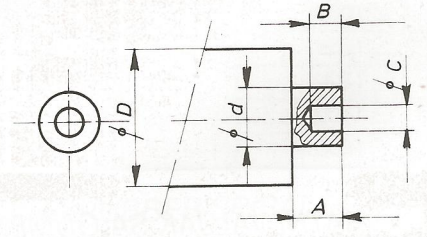

Tip – 8 – Type

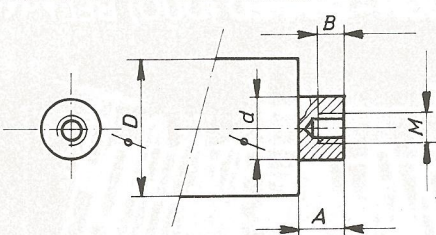

Tip – 9 – Type

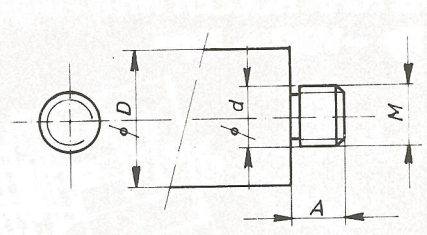

Tip – 10 – Type

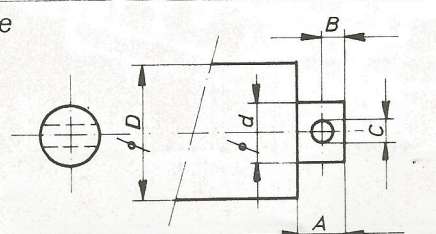

Tip – 11 – Type

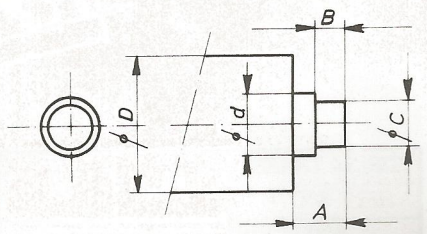

Tip – 12 – Type

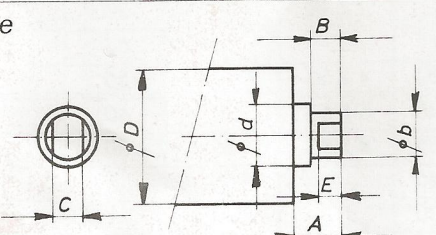

Tip – 13 – Type

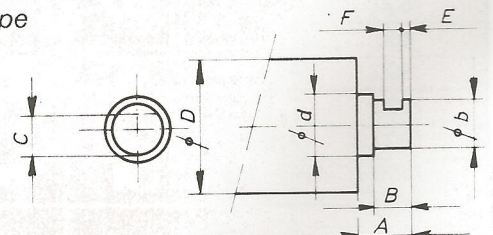

Završetke osovina, osim navedenih tipova, izrađujemo po želji kupca
 Spindle ends can be designed alternatively to client's request.